

Bevel Gears Made from Stainless Steel, Straight-Tooth System, Ratio 1:1 to 4:1

Material: Stainless steel 1.4305 (AISI 303).

Tooth quality 8 modelled on DIN 3967 (from module 2).
Crowned, milled teeth.

Shaft angle 90°.

The bevel gears only run as a pair at the stated ratio and at the same module.

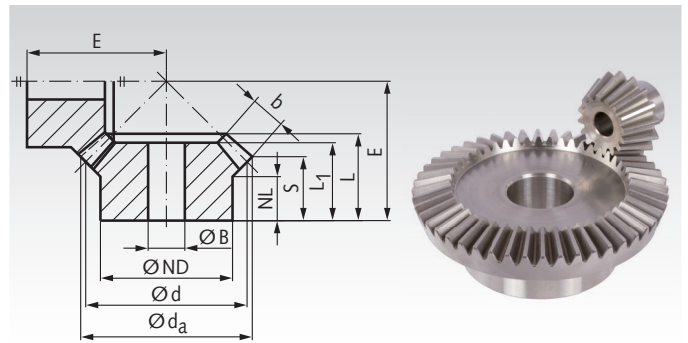

Drawing: Ratio 1:1, photo: ratio 3:1

Ordering Details: e.g.:

1 Pair of Bevel Gears Ratio 1:1 Mod. 1 16 teeth = 2 pieces Product No. 360 995 07.

1 Pair of Bevel Gears Ratio 2:1 Mod. 1 15/30 Teeth = 1 Piece Product No. 360 995 56 and 1 Piece 360 995 57.

Ratio 1:1

Product No.	Module	Number of teeth	d _a mm	d mm	ND mm	NL mm	L ₁ mm	L mm	S mm	b mm	BH7 mm	E mm	Torque* Nm	Weight g
360 995 07	1	16	17,4	16	14	7	10	11,2	8,7	4,0	5	16	0,06	9
360 997 07	1,5	16	26,1	24	20	11	15	17,3	14,1	5,1	8	25	0,19	32
361 990 07	2	16	34,8	32	25	11,5	18	20,7	16,4	6,8	10	31	0,46	66
361 991 07	2,5	16	43,7	40	30	10	21	23,8	16,8	11	10	35	1,1	120
361 994 07	3	16	52,4	48	40	12	24	27,7	18,2	15	10	40	2,0	240
361 998 07	4	16	70,0	64	50	11	29	32,9	21,0	19	20	50	4,8	420

Ratio 2:1

Product No.	Module	Number of teeth	d _a mm	d mm	ND mm	NL mm	L ₁ mm	L mm	S mm	b mm	BH7 mm	E mm	Torque* Nm	Weight g
360 995 56	1	15	17,4	15	13	6,5	11	11,9	7,6	5,0	5	22	0,08	10
360 995 57	1	30	30,6	30	20	9,0	13	15,1	13,1	5,0	5	20	0,16	40
360 997 56	1,5	15	26,1	22,5	18	6,5	13	14,8	8,4	7,6	8	30	0,27	26
360 997 57	1,5	30	45,9	45	30	12,0	18	20,7	17,6	7,6	10	28	0,54	124
361 990 56	2	15	33,7	30	20	7,5	22	23,0	10,9	14	10	40	0,78	58
361 990 57	2	30	61,8	60	40	12,0	24	27,2	21,9	14	15	35	1,56	312
361 991 56	2,5	15	42,2	37,5	30	15,6	31	33,3	18,6	17	10	55	1,6	160
361 991 57	2,5	30	77,3	75	50	10,0	24	28,1	21,6	17	15	38	3,2	530
361 994 56	3	15	50,6	45	30	11,5	33	35,4	16,4	22	10	60	2,8	270
361 994 57	3	30	92,8	90	50	10,0	26	30,7	22,3	22	20	42	5,6	750
361 998 56	4	15	67,5	60	40	10,0	38	41,0	16,9	28	20	75	6,0	410
361 998 57	4	30	123,8	120	60	15,0	33	39,4	28,8	28	25	55	12,0	1600

Ratio 3:1

Product No.	Module	Number of teeth	d _a mm	d mm	ND mm	NL mm	L ₁ mm	L mm	S mm	b mm	BH7 mm	E mm	Torque* Nm	Weight g
360 995 76	1	15	17,7	15	13	9,2	16	16,5	10,0	7,1	5	32	0,10	14
360 995 77	1	45	45,4	45	25	10	15	17,0	15,1	7,1	8	22	0,30	92
360 997 80	1,5	16	28,0	24	18	11	22	23,2	12,7	11,4	8	48	0,45	42
360 997 81	1,5	48	72,6	72	50	12	20	24,1	20,8	11,4	15	32	1,35	405
361 990 80	2	16	35,9	32	20	10	25	26,6	12,6	15	10	60	1,21	80
361 990 81	2	48	97,3	96	60	18	30	35,0	31,0	15	25	45	3,63	95
361 991 80	2,5	16	44,9	40	30	15	34	36,5	17,8	20	10	77	2,6	200
361 991 81	2,5	48	121,6	120	80	15	29	33,9	28,5	20	25	46	7,8	1600
361 994 80	3	16	53,9	48	40	12,5	36	38,3	15,0	25	15	86	4,6	310
361 994 81	3	48	145,9	144	70	18	34	38,7	32,0	25	30	53	13,8	2300
361 998 80	4	16	71,8	64	50	17	46	48,3	20,3	30	20	115	9,4	680
361 998 81	4	48	194,6	192	90	20	43	50,0	41,9	30	30	70	28,2	5700

Ratio 4:1

Product No.	Module	Number of teeth	d _a mm	d mm	ND mm	NL mm	L ₁ mm	L mm	S mm	b mm	BH7 mm	E mm	Torque* Nm	Weight g
360 995 92	1	15	17,8	15	13	7,7	17,3	17,3	8,4	9,3	5	38	0,14	15
360 995 93	1	60	60,3	60	30	10,0	15	17,1	15,1	9,3	8	22	0,56	160
360 997 92	1,5	15	26,7	22,5	18	14,45	28	28,9	15,5	13,9	8	60	0,48	42
360 997 93	1,5	60	90,4	90	50	12,0	25	27,6	24,6	13,9	15	35	1,92	745
361 990 92	2	15	34,0	30	20	13,5	29	29,9	15,5	15	10	75	1,34	80
361 990 93	2	60	120,9	120	60	20,0	35	40,1	37,0	15	25	50	5,36	1600
361 991 92	2,5	15	42,5	37,5	30	16,1	35	36,8	17,6	20	10	92	2,5	190
361 991 93	2,5	60	151,2	150	80	18,0	33	37,8	33,8	20	25	50	10,0	2600
361 994 92	3	15	51,0	45	30	13,15	38	39,7	15,7	25	10	105	4,4	270
361 994 93	3	60	181,5	180	80	18,0	35	40,6	35,5	25	30	55	17,6	3800
361 998 92	4	15	68,0	60	40	12,5	43	44,8	16,0	30	20	135	8,9	520
361 998 93	4	60	242,0	240	90	20,0	41	50,1	44,0	30	30	70	35,6	8300

* Basis for calculations see page 274.