

Bevel Gears Made from Steel, Straight-Tooth System, Ratio 2.5:1 and 3:1

Material: up to module 2: 11SMn30+SH (1.0715).
from module 2.5: C45.

Tooth quality 8 modelled on DIN 3967 (from module 2).
Up to module 5 with crowned, milled teeth.
From module 6 with planed teeth. Not hardened – not lapped.
Shaft angle = 90°.

The bevel gears only run as a pair at the stated ratio and at the same module.

Ordering Details: e.g.:

1 Pair of Bevel Gears Ratio 2.5:1 Mod. 0.5 20/50 Teeth =

1 Piece Product No. 360 272 00 and

1 Piece Product No. 360 273 00

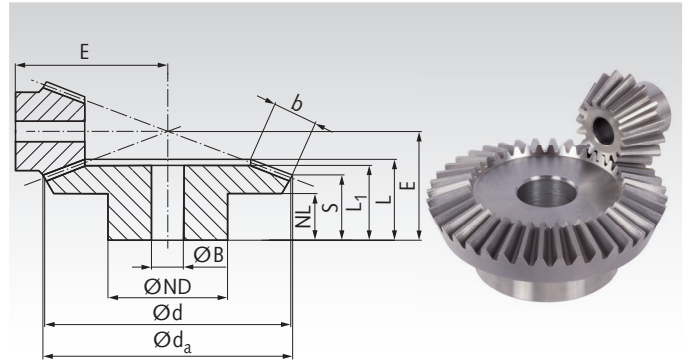

Ratio 2.5:1

Product No.	Module	Number of teeth	d _a mm	d mm	ND mm	NL mm	L ₁ mm	L mm	S mm	b mm	BH7 mm	E mm	Torque* Nm	Weight g
360 272 00	0,5	20	11,3	10	8	4,0	7	7,6	4,9	3	4	17,1	0,018	3
360 273 00	0,5	50	25,2	25	14	5,0	7	7,8	6,8	3	4	11,5	0,045	10
360 564 00	1	16	18,6	16	13	7,4	13	14,4	8,5	6,5	5	28	0,090	13
360 565 00	1	40	40,5	40	25	9,0	13	14,8	12,6	6,5	8	20	0,225	65
360 764 00	1,5	16	27,9	24	18	8,8	18	19,5	10,8	9,7	8	40	0,32	36
360 765 00	1,5	40	60,7	60	40	10,0	17	20,1	16,9	9,7	15	28	0,80	220
360 768 00	1,5	18	30,9	27	20	10,8	21	22,9	13,0	10,9	8	46	0,47	54
360 769 00	1,5	45	68,2	67,5	50	12,0	20	24,1	20,4	10,9	15	33	1,18	370
361 064 00	2	16	35,9	32	20	9,0	25	26,4	12,7	15	10	52	0,84	76
361 065 00	2	40	81,5	80	50	15,0	29	32,7	27,9	15	20	42	2,10	650
361 068 00	2	18	39,8	36	30	11,8	26	27,4	13,8	15	10	58	1,18	133
361 069 00	2	45	91,5	90	60	18,0	30	33,8	28,9	15	25	45	2,95	830
361 164 00	2,5	16	44,8	40	30	13,0	32	34,1	15,9	20	10	65	5,0	180
361 165 00	2,5	40	101,9	100	60	15,0	29	33,8	27,4	20	25	45	12,5	1000
361 168 00	2,5	18	49,8	45	30	15,75	36	37,9	19,7	20	10	75	7,1	240
361 169 00	2,5	45	114,4	112,5	70	15,0	28	33,4	26,9	20	25	47	17,8	1200
361 464 00	3	16	53,8	48	40	13,6	37	38,8	16,1	25	15	75	9,0	310
361 465 00	3	40	122,3	120	60	16,0	32	36,8	28,9	25	25	50	22,5	1400
361 468 00	3	18	59,8	54	40	11,7	36	38,4	15,7	25	15	82	12,8	380
361 469 00	3	45	137,3	135	70	18,0	34	39,0	30,9	25	30	55	32,0	1900
361 864 00	4	16	71,8	64	50	12,0	41	43,8	16,5	30	20	95	20,9	600
361 865 00	4	40	163,1	160	80	20,0	40	46,4	36,9	30	30	65	52,3	3400
361 868 00	4	18	79,7	72	50	13,8	44	46,8	19,5	30	20	108	29,3	800
361 869 00	4	45	183,0	180	90	20,0	43	49,6	39,9	30	30	72	73,3	4900
362 168 00	5	18	99,6	90	60	16,5	57	60,8	24,4	40	25	135	61,0	1560
362 169 00	5	45	228,8	225	100	20,0	50	57,8	44,8	40	40	85	152,5	9080

Ratio 3:1

Product No.	Module	Number of teeth	d _a mm	d mm	ND mm	NL mm	L ₁ mm	L mm	S mm	b mm	BH7 mm	E mm	Torque* Nm	Weight g
360 276 00	0,5	15	8,0	7,5	6	3,7	6,5	7,0	4,3	3	3	15,3	0,009	1
360 277 00	0,5	45	22,7	22,5	12	5,0	7,5	8,4	7,5	3	4	11,0	0,027	10
360 576 00	1	15	17,7	15	13	9,2	16	16,5	10,0	7,1	5	32	0,086	14
360 577 00	1	45	45,4	45	25	10	15	17,0	15,1	7,1	8	22	0,258	92
360 780 00	1,5	16	28	24	18	11	22	23,2	12,7	11,4	8	48	0,38	42
360 781 00	1,5	48	72,6	72	50	12	20	24,1	20,8	11,4	15	32	1,14	405
361 080 00	2	16	35,9	32	20	10	25	26,6	12,6	15	10	60	0,92	80
361 081 00	2	48	97,3	96	60	18	30	35,0	31,0	15	25	45	2,76	950
361 180 00	2,5	16	44,9	40	30	15,35	34	36,5	17,8	20	10	77	5,6	200
361 181 00	2,5	48	121,6	120	80	15	29	33,9	28,5	20	25	46	16,8	1600
361 480 00	3	16	53,9	48	40	12,5	36	38,3	15,0	25	15	86	10,0	310
361 481 00	3	48	145,9	144	70	18	34	38,7	32,0	25	30	53	30,0	2300
361 880 00	4	16	71,8	64	50	17	46	48,3	20,3	30	20	115	22,9	680
361 881 00	4	48	194,6	192	90	20	43	50,0	41,9	30	30	70	68,7	5700
362 176 00	5	15	84,9	75	60	15	53	56,4	19,1	40	20	130	39,3	1110
362 177 00	5	45	228,3	225	100	20	45	53,1	42,4	40	40	75	117,9	7920
362 180 00	5	16	89,8	80	60	16,5	55	59,0	21,6	40	20	140	47,7	1310
362 181 00	5	48	243,2	240	100	20	47	55,7	44,9	40	40	80	143,1	9640
367 376 00	6	15	101,4	90	70	20	67	73	26,2	50	30	159,2	70,7	1880
367 377 00	6	45	273,8	270	100	30	60	69	55,0	50	45	94,3	212,1	13170

* Basis for calculations see page 274.

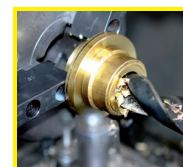

**Reworking within
24h-service possible.
Custom made parts
on request.**